

Red Swastika School
Primary 4
Class Test 2
Mathematics

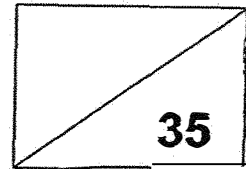

Name: _____ ()

Date: 5 Aug 2025

Class: Pr 4 / _____

Duration: 45 minutes

Parent's Signature: _____

Section A

Questions 1 to 2 carry 1 mark each. Questions 3 to 5 carry 2 marks each.
For each question, four options are given. One of them is the correct answer.
Make your choice (1, 2, 3 or 4) and shade your answer in the Optical Answer Sheet.
(8 marks)

- 1 The figure is made up of identical triangles. What fraction of the figure is shaded?

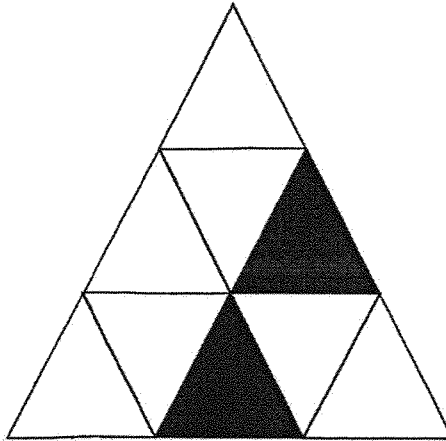

- (1) $\frac{2}{7}$
(2) $\frac{2}{9}$
(3) $\frac{7}{2}$
(4) $\frac{7}{9}$

- 2 In the figure below, which angle is greater than a right angle?

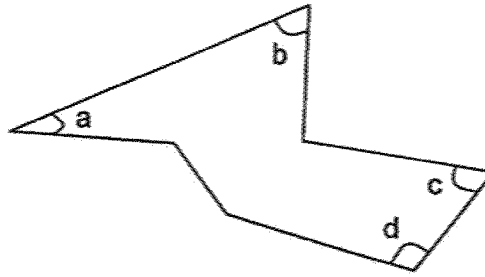

- (1) $\angle a$
- (2) $\angle b$
- (3) $\angle c$
- (4) $\angle d$

- 3 In which of the following does the digit '4' stand for 4 hundredths?

- (1) 460.57
- (2) 124.85
- (3) 65.47
- (4) 92.54

- 4 In the figure below, which of the following lines is perpendicular to AB?

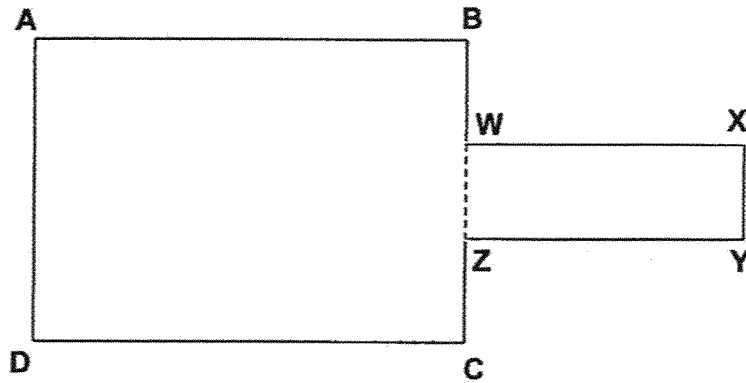

- (1) BW
 - (2) CD
 - (3) WX
 - (4) YZ
- 5 The figure below is made up of a rectangle ABCD and a square CEFG. Find the length of DE.

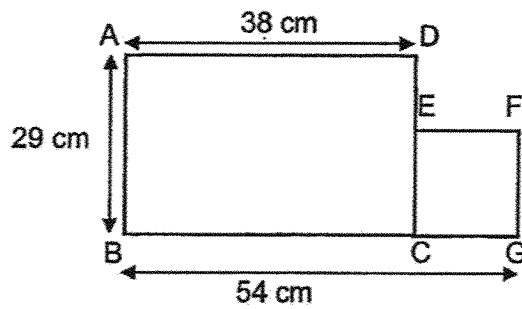

- (1) 22 cm
- (2) 16 cm
- (3) 13 cm
- (4) 9 cm

Section B

Questions 6 to 13 carry 2 marks each. Write your answers in the spaces provided.
For questions which require units, give your answers in the units stated. (16 marks)

6 (a) Write $\frac{15}{7}$ as a mixed number.

Ans: (a) _____

(b) Express 0.75 as a fraction in its simplest form.

Ans: (b) _____

7 (a) Arrange the following in decreasing order.

$$\frac{13}{5}, 2\frac{3}{4}, \frac{7}{8}$$

Ans: (a) _____ , _____ , _____
(greatest)

(b) What is the missing number in the box?

$$\frac{15}{24} = \frac{\square}{8}$$

Ans: (b) _____

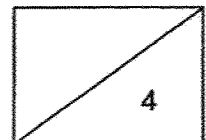

8 Look at the figure below and answer 8a and 8b.

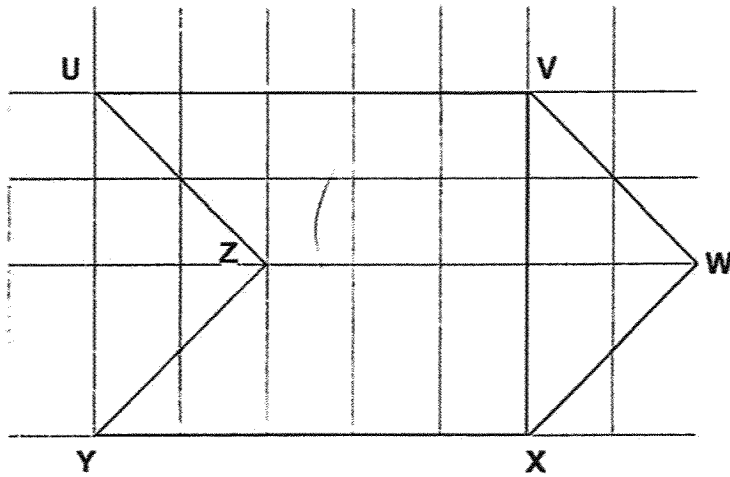

(a) How many pairs of parallel lines are there in the figure?

Ans: (a) _____

(b) Name a pair of perpendicular lines.

Ans: (b) _____ \perp _____

9 (a) A number has 2 decimal places. It is 34.7 when rounded to 1 decimal place. What is the smallest possible number?

Ans: (a) _____

(b) In the number line shown, write the decimal represented by the letter A.

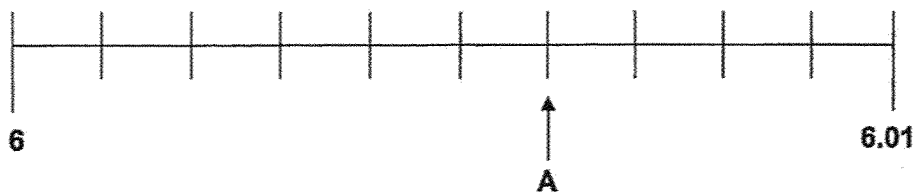

Ans : (b) _____

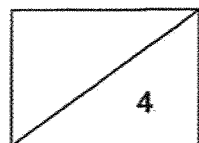

- 10 Leonard had \$120. He spent $\frac{5}{8}$ of his money and saved the rest. How much did Leonard save?

Ans: \$ _____

- 11 The figure below shows a square ABCD. Find $\angle y$.

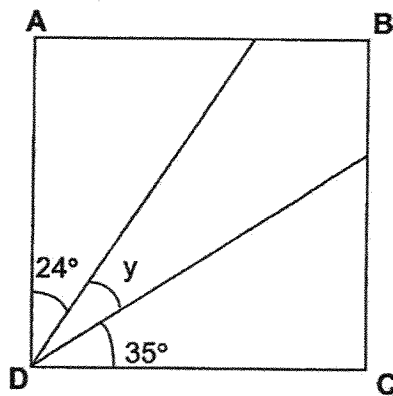

Ans: _____ °

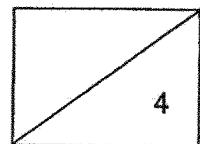

- 12 Sophia drank $\frac{7}{10}$ ℓ of apple juice. John drank $\frac{1}{5}$ ℓ of apple juice less than her. How much apple juice did they drink altogether? Give your answer as a decimal.

Ans: _____ ℓ

- 13 Helen was preparing for her Science examination. She managed to revise $\frac{1}{4}$ of her textbook on Saturday and $\frac{1}{6}$ of it on Sunday. She had 98 more pages to read. How many pages were there in the textbook?

Ans: _____

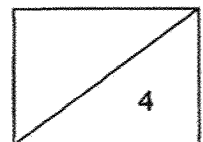

Section C

For Questions 14 to 16, show your workings clearly in the space below each question and write your answers in the spaces provided. (11 marks)

- 14 (a) Use a protractor to measure $\angle XYZ$.

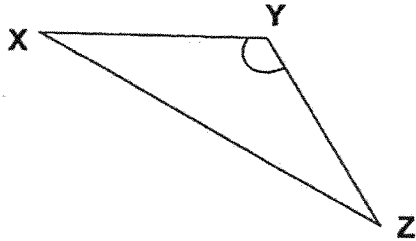

Ans: (a) _____ ° [1]

- (b) AB and BC are two sides of a square. Draw and label square ABCD in the grid. [1]

- (c) Draw a rectangle BCEF such that its length is twice its breadth and BC is one of its breadths. [1]

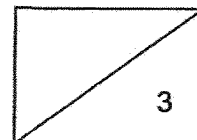
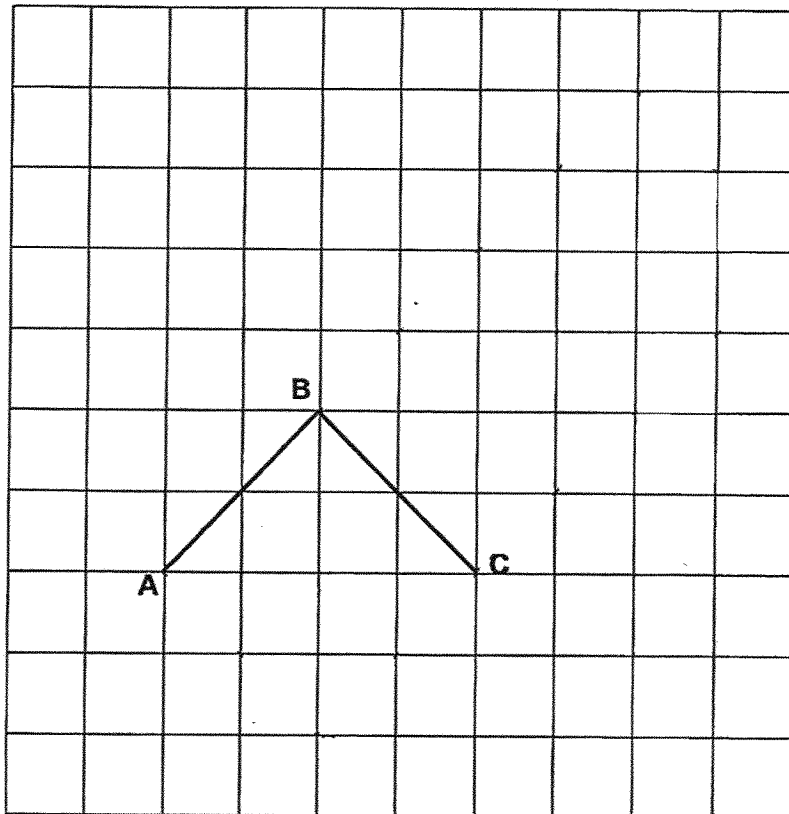

- 15 Ali, Benny and Charles have some marbles.
Benny has three times as many marbles as Ali.
Charles has $\frac{1}{2}$ of the total number of marbles that Ali and Benny have altogether.

(a) The total number of marbles the 3 boys have is 1260. How many marbles does Benny have?

Ans: (a) _____ [2]

(b) Charles gave $\frac{5}{6}$ of his marbles to his brother. How many marbles did he have left?

Ans: (b) _____ [2]

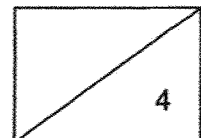

- 16 There are some beads in a box. $\frac{7}{9}$ of them are red beads and the rest are blue beads. There are 130 more red beads than blue beads.

(a) What fraction of the beads are blue?

Ans: (a) _____ [1]

(b) How many beads are there in the box?

Ans: (b) _____ [3]

END OF PAPER

10

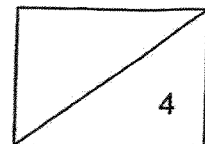

SCHOOL : RED SWASTIKA PRIMARY SCHOOL
LEVEL : PRIMARY 4
SUBJECT : MATHEMATICS
TERM : 2025 WEIGHTED ASSESSMENT 2

Q1	Q2	Q3	Q4	Q5					
2	4	4	1	3					

Q6	a) $2\frac{1}{7}$ b) $\frac{3}{4}$
Q7	a) $2\frac{3}{4}, \frac{13}{5}, \frac{7}{8}$ b) 5
Q8	a) 3 b) VW / WX
Q9	a) 34.65 b) 6.006
Q10	$8u = 120$ $1u = 120 \div 8 = 15$ $3u = 15 \times 3 = \$45$
Q11	$35 + 24 = 59$ $90 - 59 = 31^\circ$
Q12	$\frac{7}{10} + \frac{5}{10} = \frac{12}{10} = 1.2 \text{ L}$
Q13	$\frac{1}{4} + \frac{1}{6} = \frac{3}{12} + \frac{2}{12} = \frac{5}{12}$ (Sat and Sun) Left: $1 - \frac{5}{12} = \frac{7}{12}$ $7u=98$

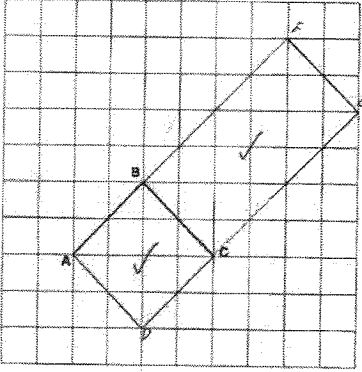
	$1u = 98 \div 7 = 14$ $12u = 14 \times 12 = 168$
Q14)	<p>a) 122°</p> <p>b),c)</p> 
Q15)	<p>a) $1260 \div 6 = 210$</p> <p>$210 \times 3 = 630$</p> <p>b) $C \rightarrow 2u = 210 \times 2 = 420$</p> <p>$6u = 420$</p> <p>$1u = 420 \div 6 = 70$</p>
Q16)	<p>a) $\frac{2}{9}$</p> <p>b) $5u = 130$</p> <p>$1u = 130 \div 5 = 26$</p> <p>$9u = 26 \times 9 = 234$</p>